

支架

CARACTERÍSTICAS:

1 Teste Elétrico:

- A. 250 V CA máx. a 2 amperes.
- B. Dielétrico com corrente alternada de 500 volts.
- C. Resistência de isolamento: 500 megaohms.
- D. Resistência de terminação: 35megaohms.

2 Mecânica:

- A. Força tênsil corpo a corpo - 20LBs(89N)min.
- B. Durabilidade: 750 ciclos de acoplamento.

FEATURES:

1 Electrical Test:

- A. 250V AC max at 2 amps.
- B. Dielectric with standing 500volts AC.
- C. Insulation Resistance:500 megaohms.
- D. Termination Resistance:35megaohms.

2 Mechanical:

- A. Cable-to-Plug tensile strength-20LBs(89N)min.
- B. Durability:750 mating cycles.

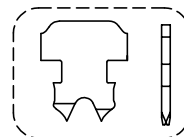
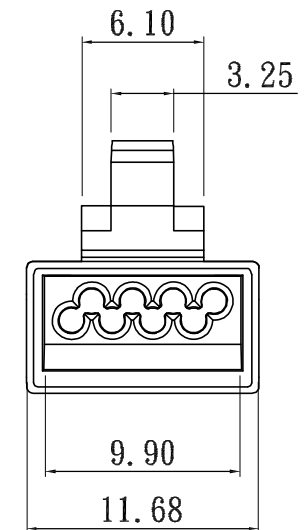
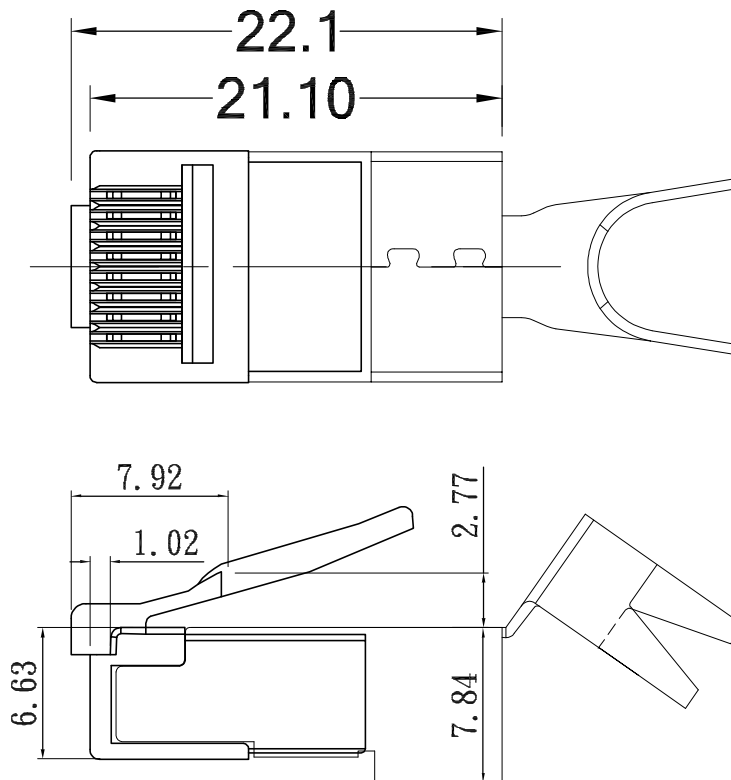

A : Fio flexível

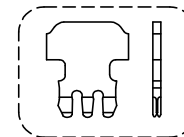

H : Fio sólido

062-0056